

# Zebra - 3.5NSX screen case

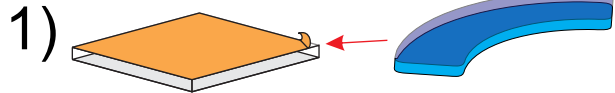

You can use the included acrylic tool to help peel protective paper.  
If it's particularly stubborn you can soak the acrylic parts in warm water to soften the adhesive.

Remove micro SD card from pi before assembly

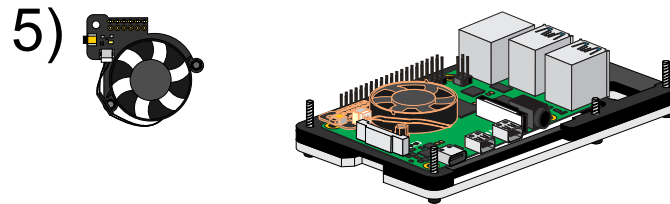
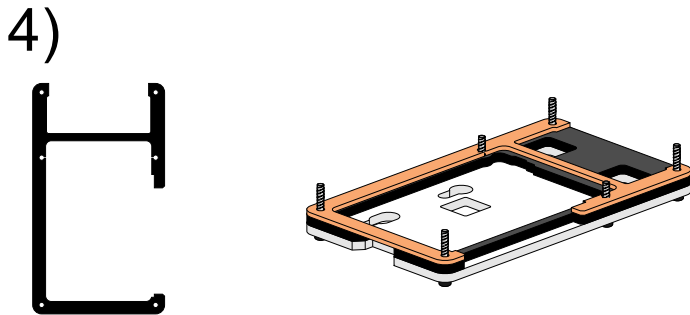
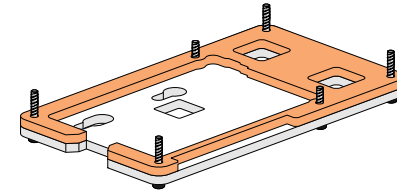
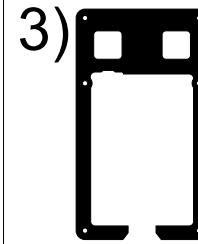
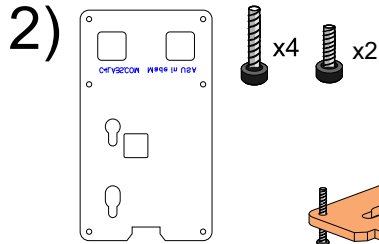
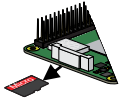

**Optional**  
This case is designed to be compatible with The Pimoroni Fan SHIM (not included)  
It is highly recommended to use a fan with the Pi-4B as it is known to run hot and can effect software performance.

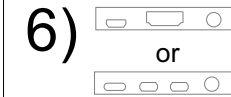

Chose the faceplate that fits with your model of Raspberry pi

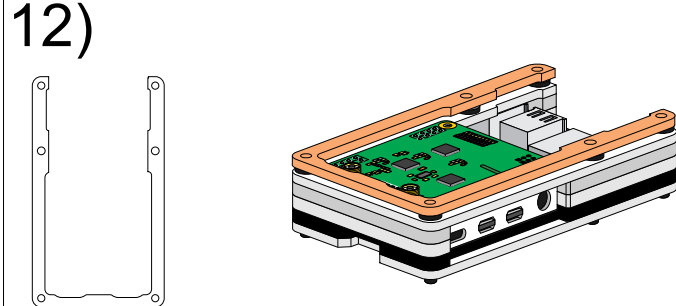
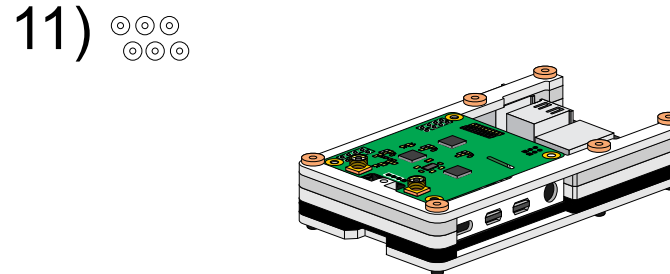
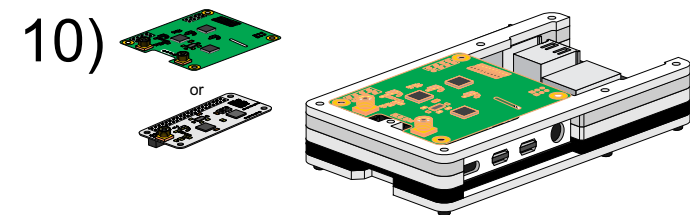
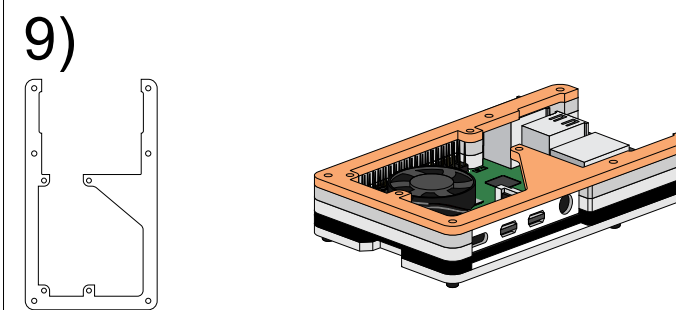
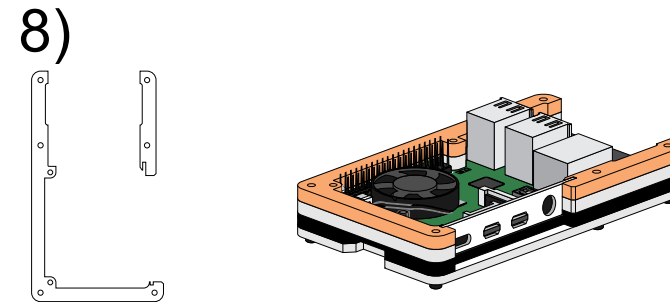
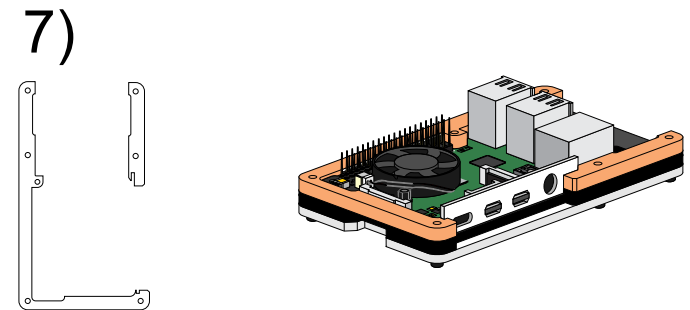
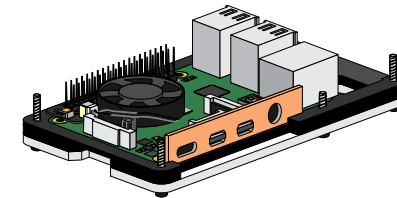

**Add Zumspot and connect Nextion screen.**  
Please note that connecting the Nextion Screen to your setup may require additional soldering of pins and wires not covered in these case instructions.



C4LABS.COM



13)

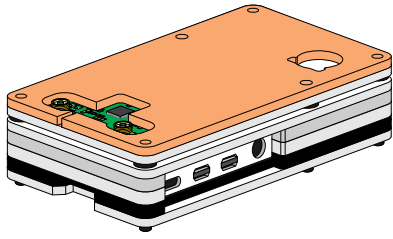
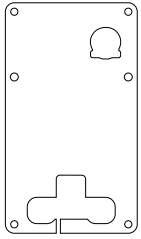

14)  x2

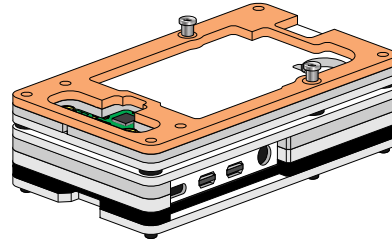
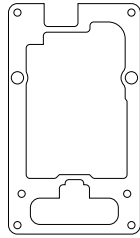

15)

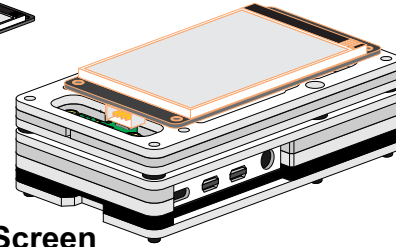
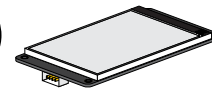

**Layer on Nextion Screen**

For mmdvm and screen support visit:  
<https://www.facebook.com/groups/Nextion/>

16)

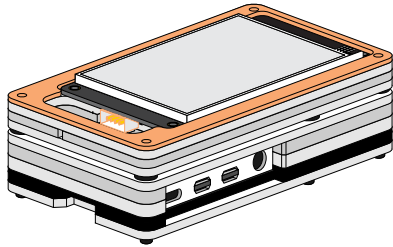
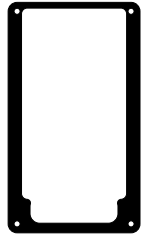

17) Depending on the radio board being used the top will have one or two holes

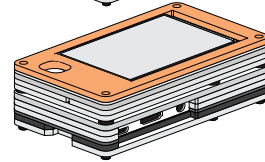
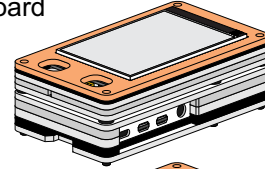
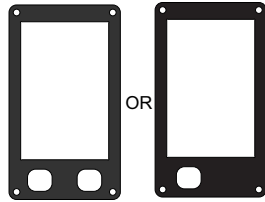

18)  x4

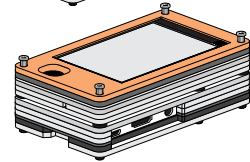
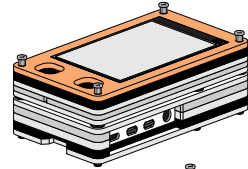
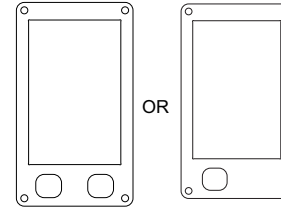

C4LABS.COM

